



DEPLOY

IPv6 Protocol (headers & options)

IPv6 Workshop

Trieste, Italy – 28th February / 1st March 2011



Copy ...Rights

This slide set is the ownership of the 6DEPLOY-2 project via its partners

The Powerpoint version of this material may be reused and modified only with written authorization

Using part of this material must mention 6DEPLOY-2 courtesy

PDF files are available from www.6deploy.eu

Looking for a contact ?

- ***Mail to : martin.potts@martel-consulting.ch***
- ***Or bernard.tuy@renater.fr***

Contribs

B. Tuy, RENATER

L. Toutain, ENST-B



Updates

B. Tuy 20/05/2008



Agenda

IPv6 Header

- Comparison with IPv4

IPv6 optional headers (extensions)

Processing IPv6 headers

- Comparison with IPv4

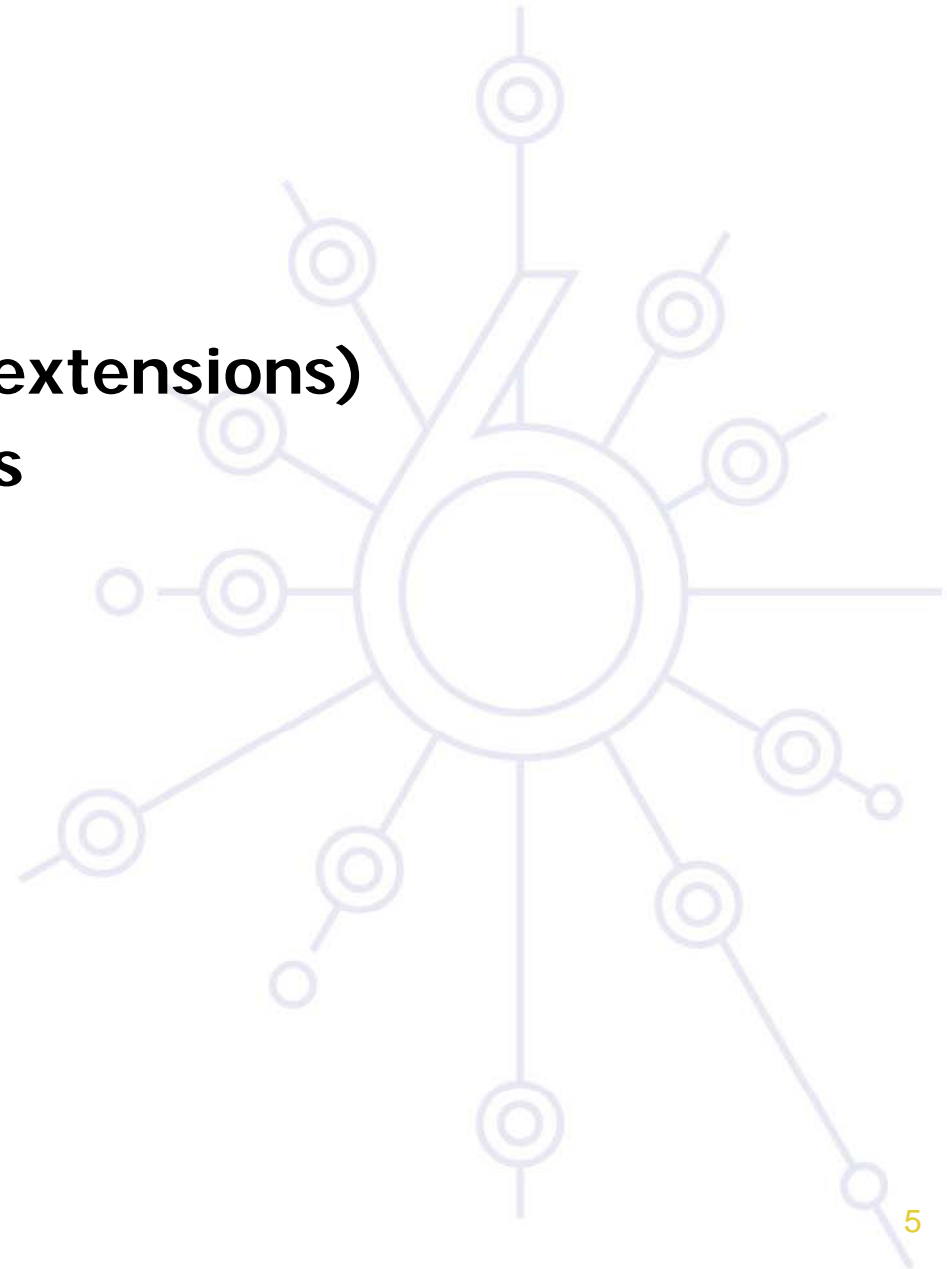

IPv6 Header

The IPv6 header is designed

- To minimize header overhead
- and reduce the header process for most of the packets
- Less important information and option fields are moved to *extension headers*

⇒ **IPv6 & IPv4 headers are not interoperable**

IPv4 Header

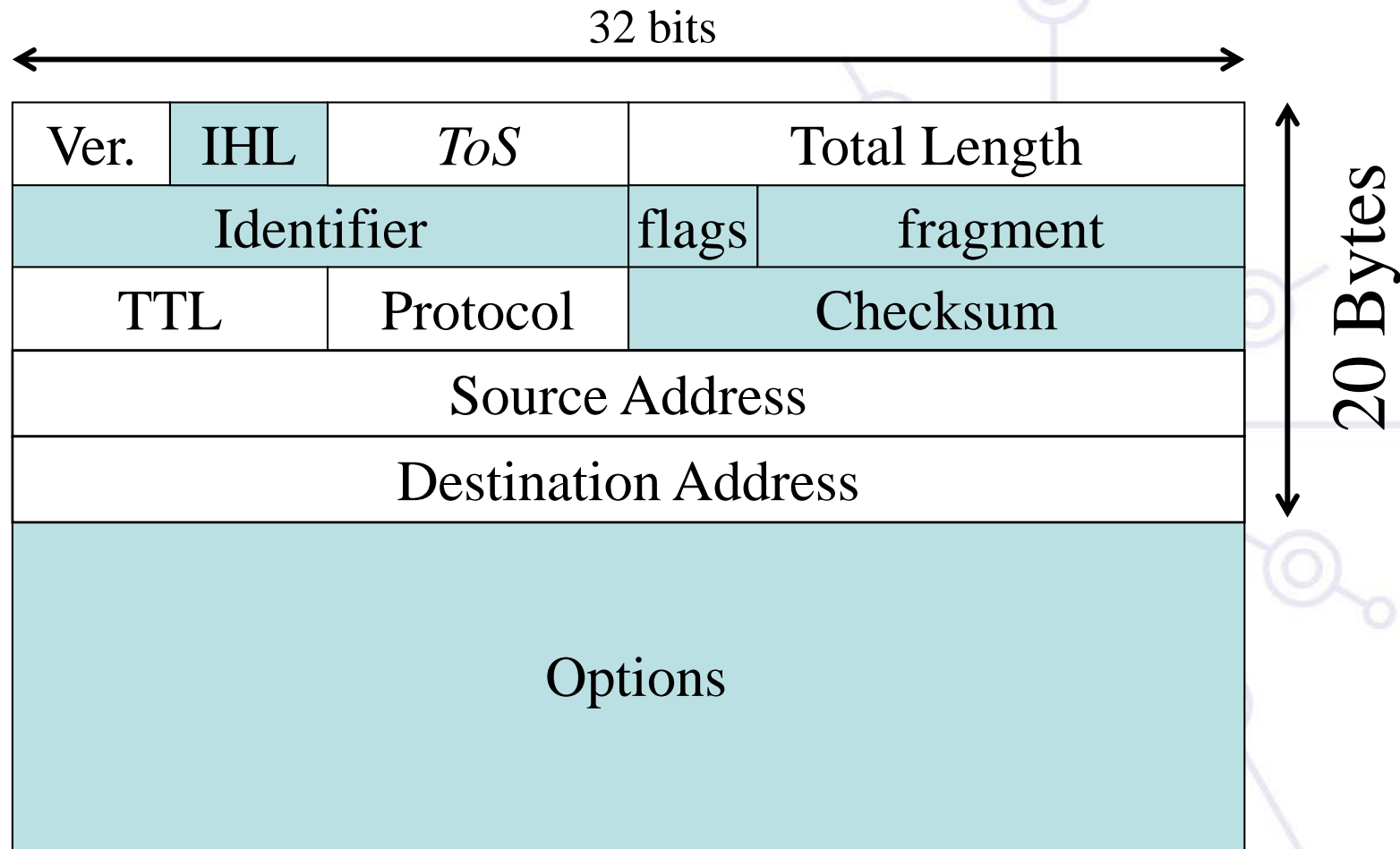

IPv6 Header simplification

32 bits

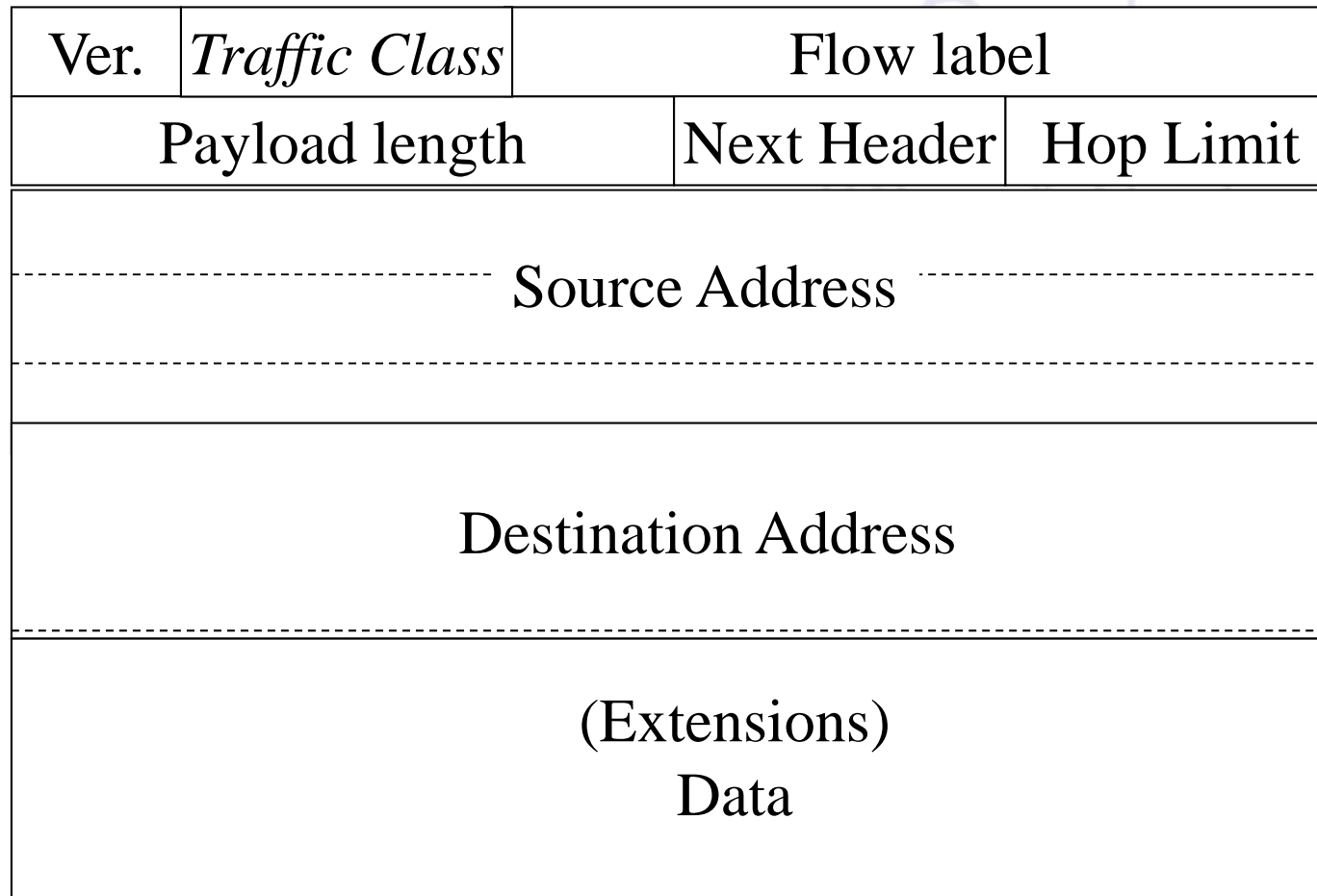

40 Bytes

IPv6 header fields

Version

- 4 bits

Traffic class (*see next slide*)

- 8 bits

Flow label (*see next slide*)

- 20 bits

Payload length

- Use Jumbogram for specific cases (payload = 0)
- 16 bits

Hop limit

- 8 bits

Next header

- 8 bits

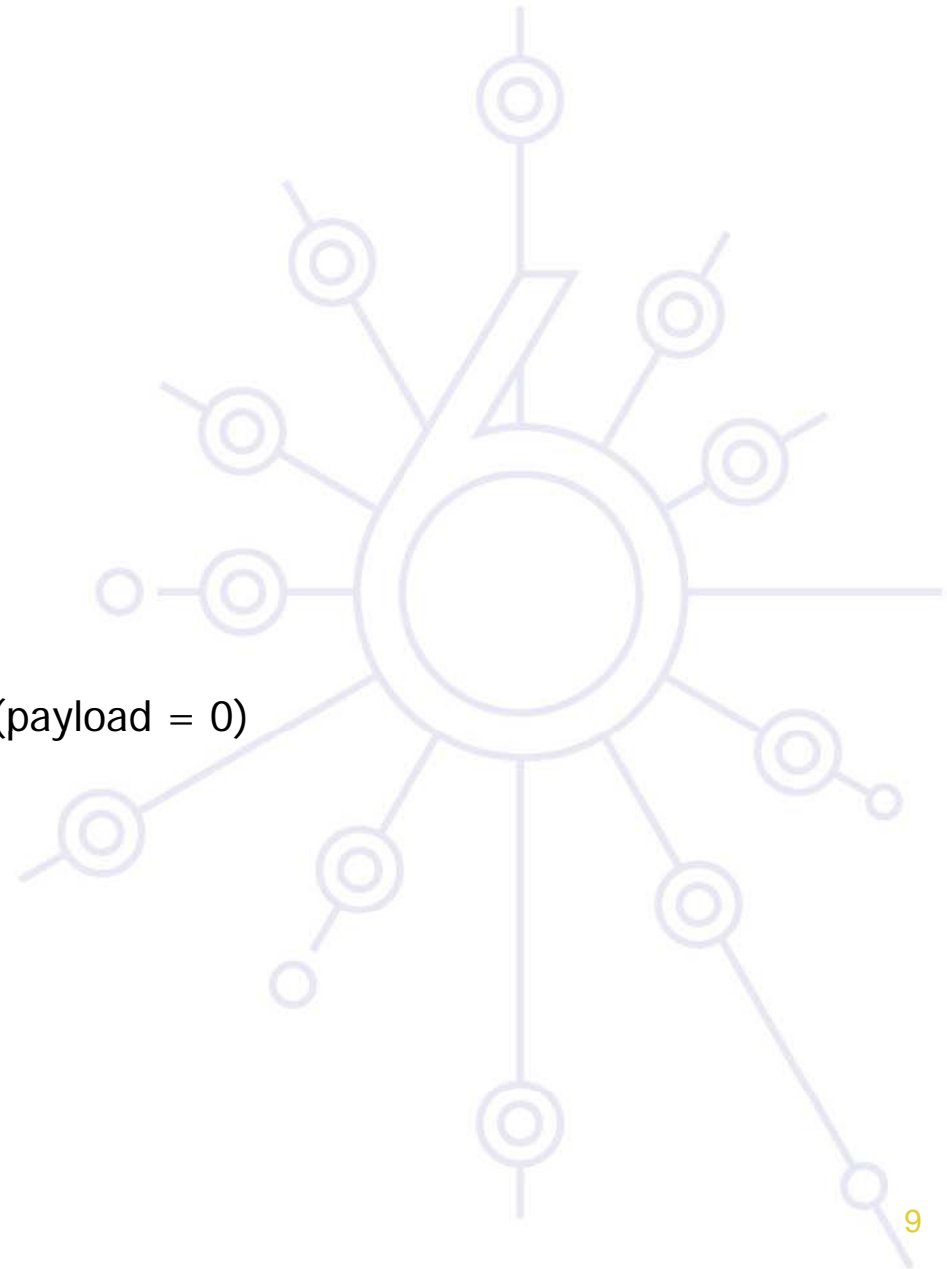

CoS support in IPv6

The Traffic Class field: *used as in IPv4*

- Work done in diffserv wg (closed): RFCs **2474**, 2475, 2597, 3260, ...



CU is Currently Unused (reserved)

The Flow Label field: designed to enable classification of packets belonging to a specific flow

- **A flow** is a sequence of packets that should receive specific non-default handling from the network
- Intuitively: 5-tuple of the same source/destination address/port and transport protocol values
- Without the flow label the classifier must use transport next header value and port numbers
 - Less efficient (need to parse the option headers)
 - May be impossible (fragmentation or IPsec ESP)
- Further info:
 - RFC 3697 (PS)

IPv6: optional Extensions

New “mechanism” replacing IPv4 options

An IPv6 extension :

- Every extension has its own message format
- Is a $n \times 8$ -byte datagram
- Starts with a 1-byte ‘Next Header’ field
 - Pointing to either another extension or a L-4 protocol

Hop-by-hop (jumbogram, router alert)

- Always the first extension
- Analyzed by every router.

Destination

Routing (*loose source routing*)

Fragmentation

Security

- Authentication (AH)
- Encapsulating Security Payload (ESP) : confidentiality

Order is important (RFC 2460)

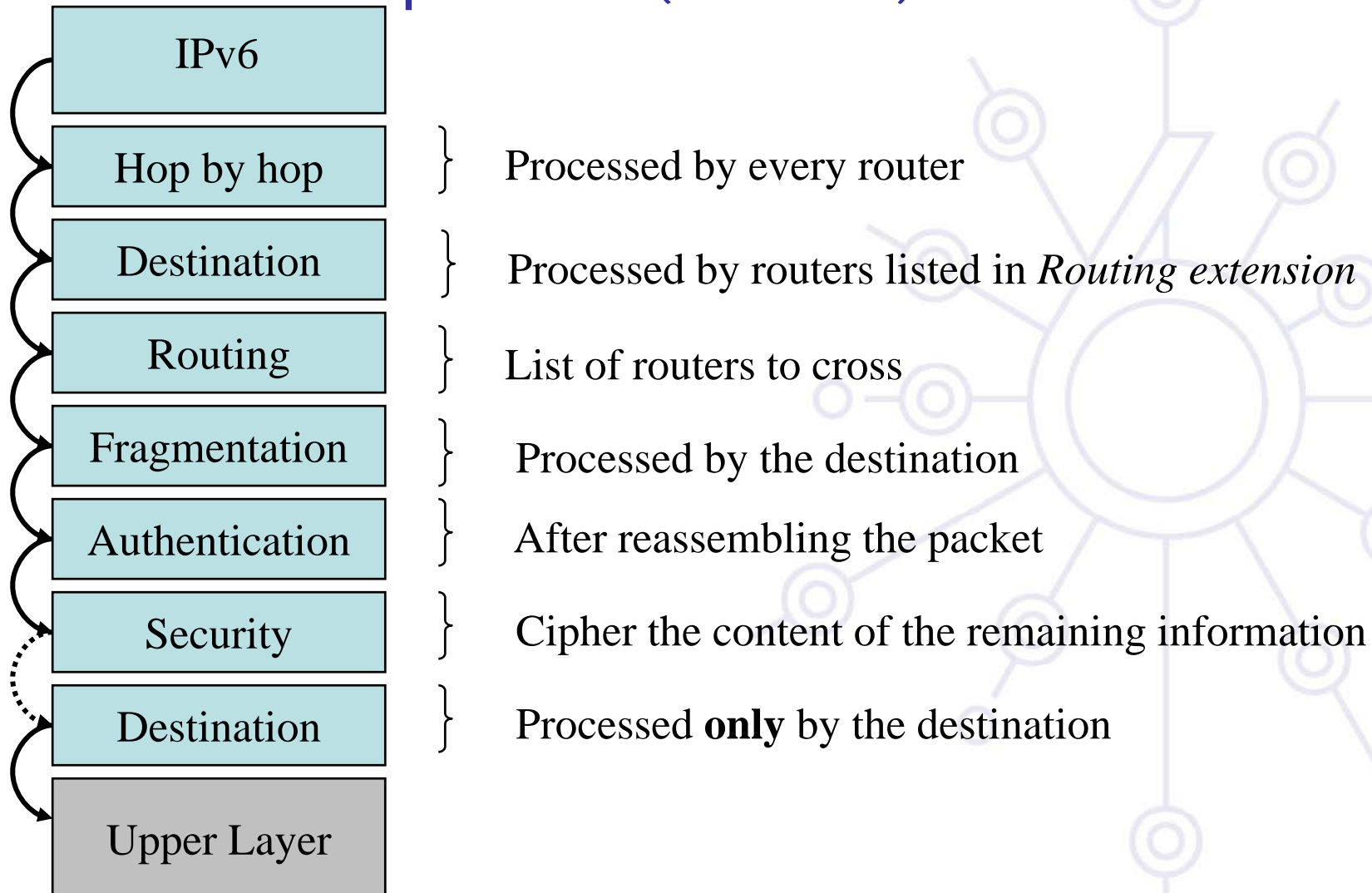

IPv6: Optional headers

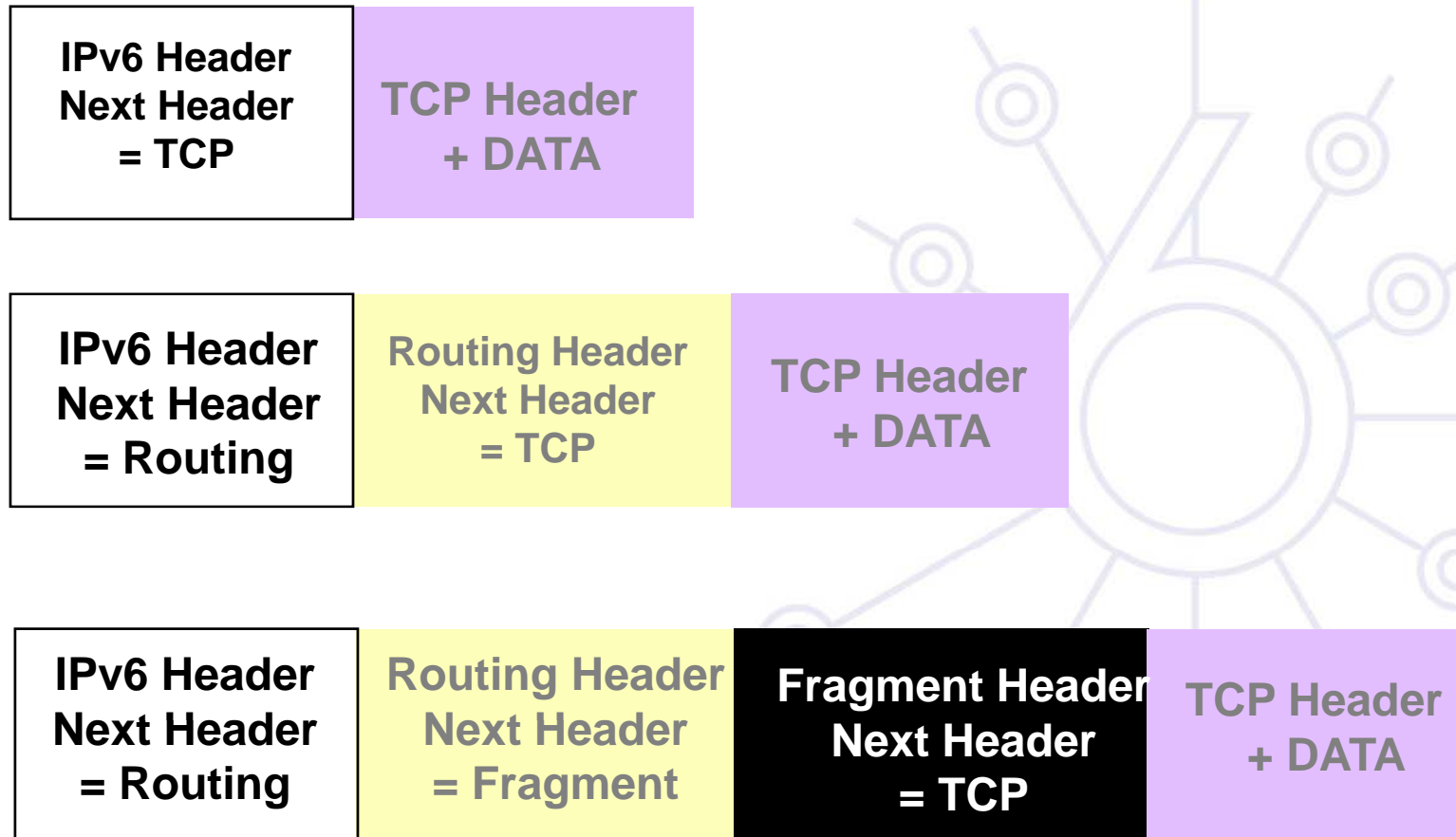

IPv4 header options processing

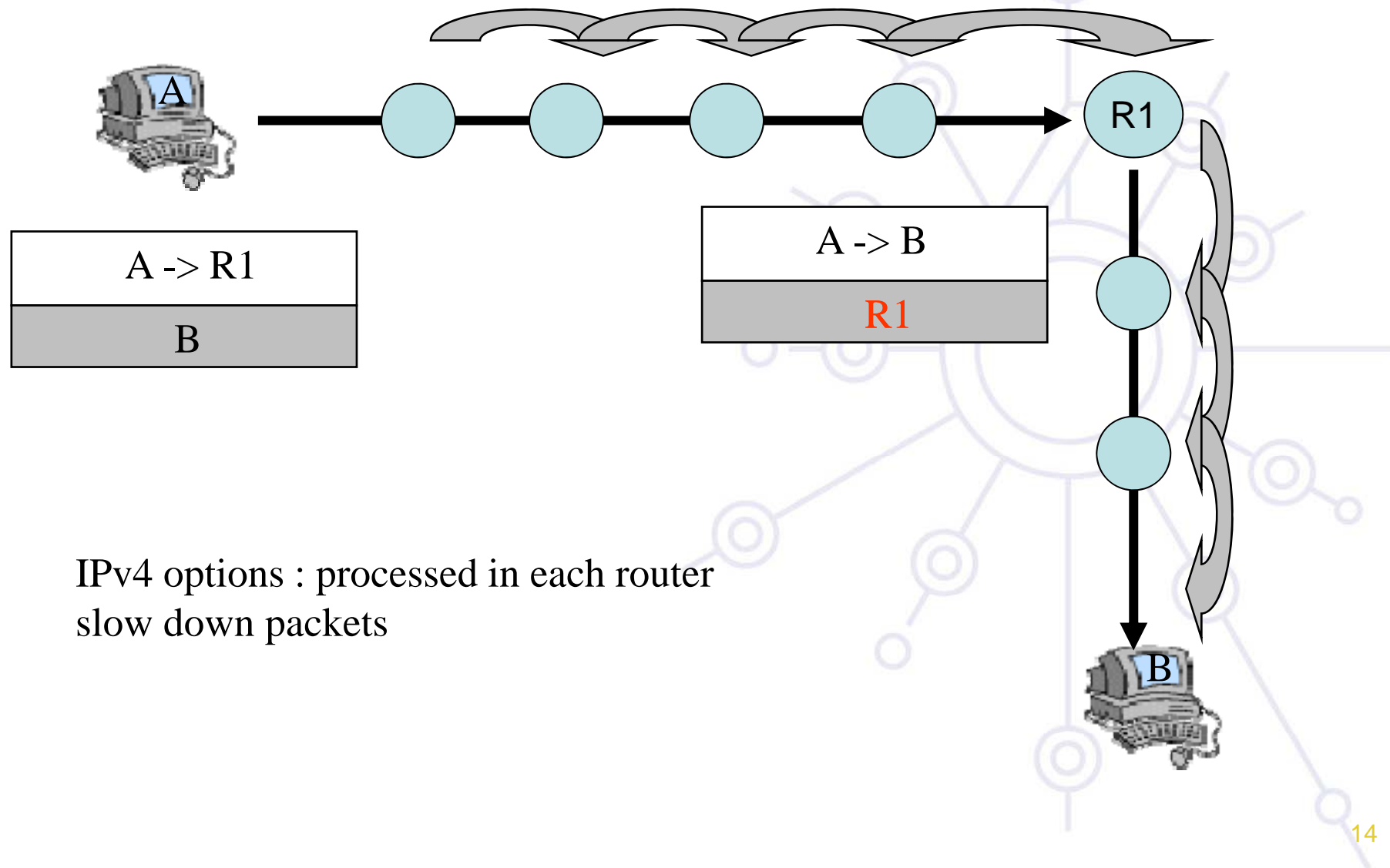

IPv4 options : processed in each router
slow down packets

IPv6 ext. header processing

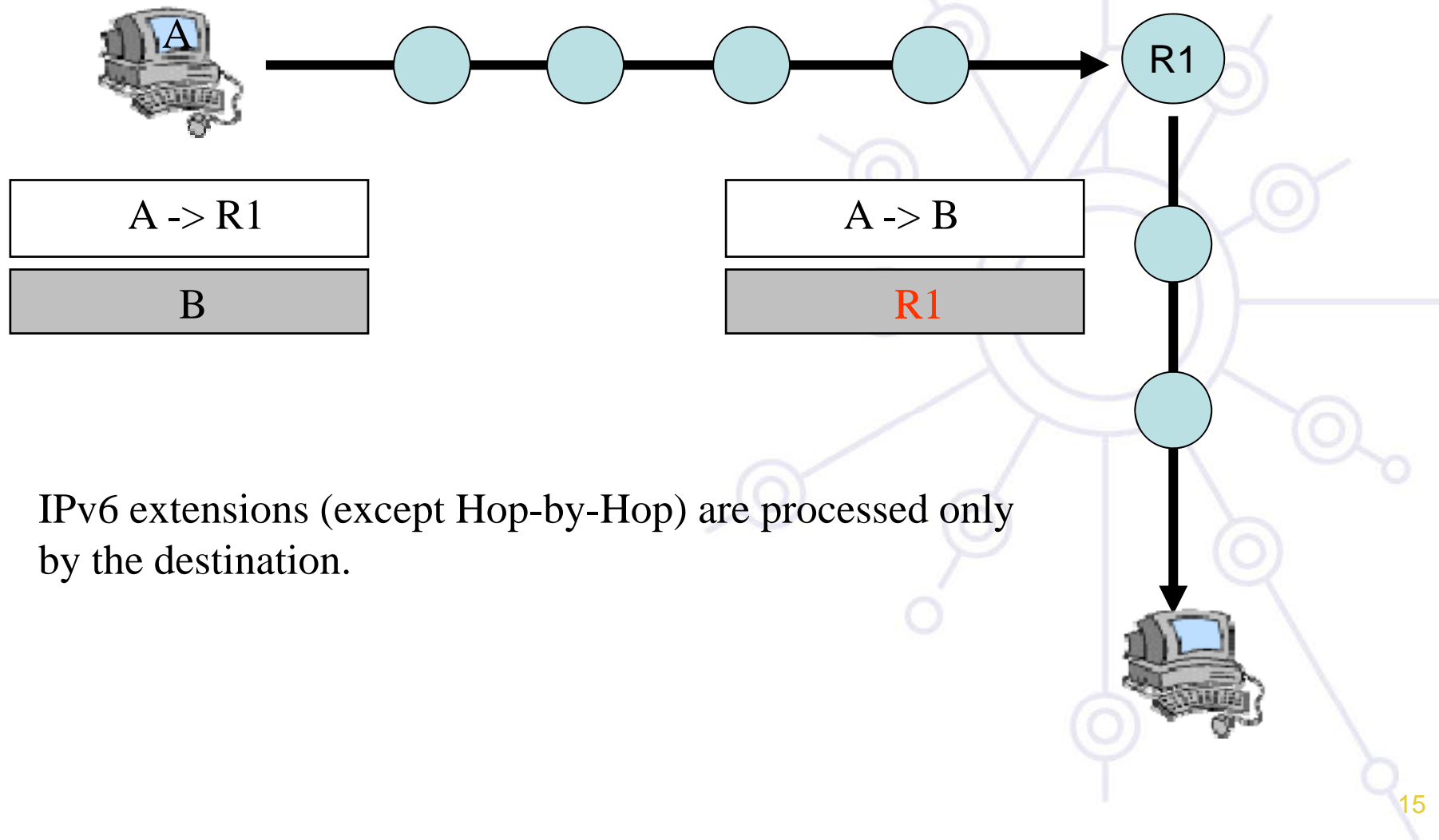

Conclusion

Main changes in IPv6 protocol are within address format and datagram headers

- **A lot of fields in the IPv6 header have disappeared**
 - ⇒ More efficient processing in the (intermediate) routers
- **Optional extensions allow more functionalities (source routing, authentication, ...)**
- **Optional header mechanism allows new options introduction without modifying the protocol**



deploy

Questions ...